



Model **N810** [Near Infrared]

NewDEL™ NIR Fiber-coupled LED

Meticulously engineered photonic tools built to advance the goals of our customers, whether they are forging new paths in scientific discovery or implementing an ongoing project.



The NewDEL™ NIR product group of fiber-coupled LEDs combines narrowband output at wavelengths targeting key NIR applications. As with other narrowband models in the NewDEL™ incorporates controller and driver circuitry and uses PWM dimming exclusively to prevent wavelength drift. Contact us if you need wavelengths not already listed on our website.

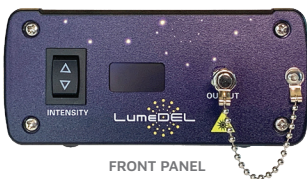

FRONT PANEL



REAR PANEL

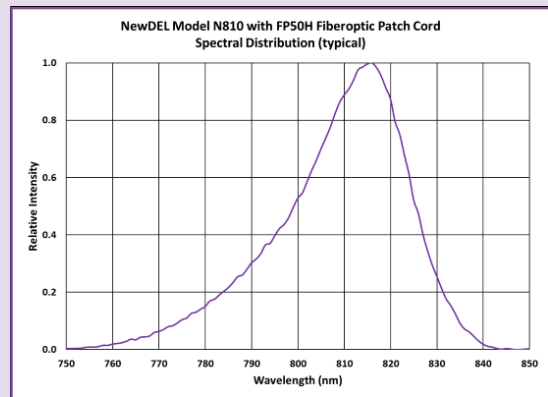

SPECIFICATIONS

- Center wavelength: **810 nm**
- FWHM: 37 nm
- Recommended fiber patch cable: Model **FP50H**, High-OH Silica Optical Fiber, NA 0.50
 - Optical power emitted (typical maximum): **140 mW**
- SMA905 connector (FC option upon request)

APPLICATIONS

- Iris recognition (biometrics)
- Photobiomodulation of bone metabolism and diabetic wound healing
- ICG fluorescence guided surgery
- CCTV illumination

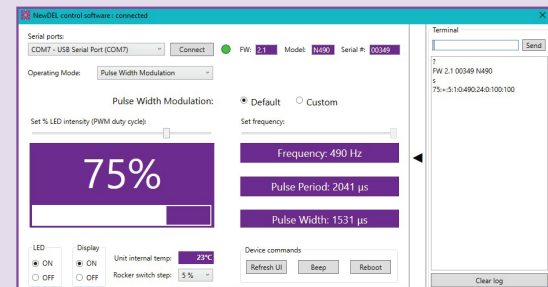

SOFTWARE INTERFACE



500 N. Commercial St.
Suite 502E
Manchester, NH 03101



P: +1 603.802.2242
F: +1 603.802.2245

info@lumedel.com
www.lumedel.com

NewDEL™ Dimensions

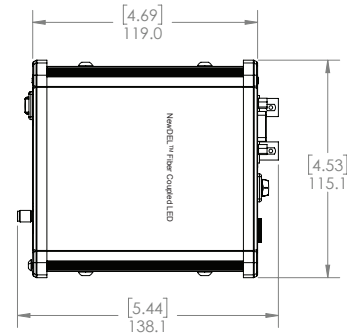
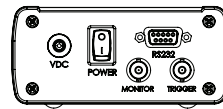
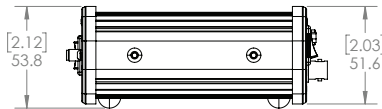
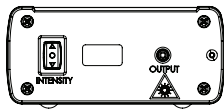

NewDEL™ Specifications

Optical coupling	SMA 905 type connector for multi-mode optical fibers with core diameters up to 1000 μm (FC connector optional)	2.12 53.8	2.03 51.6
Optical output power (typical)	140 mW		
Center Wavelength	810 nm +/- 5 nm		
Operating modes - Pulse Width Modulation	Default 490Hz Custom (user set) 1-500Hz		
Operating modes - Internal Trigger	Set Pulse Delay 10ms – 32s Set Pulse Duration 10ms – 32s		
Operating modes - External Trigger	LED output controlled by 0-5V TTL		
Serial Interface	RS-232, DB-9 female Converter cable RS-232 to USB-A (FTDI) is included		
Trigger connector	Optically isolated BNC, 50 Ohms for External Trigger mode Cable not included		
Monitor connector	BNC, 50 Ohms for reading PWM or pulse waveform Cable not included		
Manual operation	Front panel intensity switch for Pulse Width Modulation mode Step size set by software; 1, 2, 4, 5, or 10 percent		
Remote Operation - Software	Windows based GUI, available by download		
Remote Operation - Programmability	Serial commands are provided to control a unit and query its status using a terminal program or other suitable programming systems		
Front Panel Display	Passive Matrix OLED, can be deactivated through software % PWM Intensity or trigger operating mode with frequency		
Thermal management	Passive cooling via conduction Internal temperature sensor/monitor readable by software		
Power supply	Universal AC/DC Wall adapter, 90 to 264VAC at 47 to 63Hz input 12V 12W output, 1.5 m cord length, DOE VI Efficiency, Class B EMI, Safety Approvals: cUL/UL, RCM, CB, CE (international socket blade options)		
Dimensions/Weight	4.7 x 4.5 x 2.0 in (119.1 x 115.1 x 51.6 mm) / 1.1 lbs (0.5 kg)		

Peripherals & Accessories

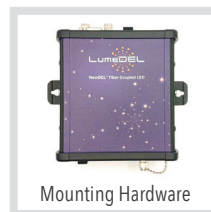

All specifications are subject to change without notice. | All LumeDEL™ Terms and Conditions apply see: <https://lumedel.com/terms-of-sale/>

Copyright © 2023 LumeDEL LLC. All rights reserved.