



Model X4010 [Broadband]

## NewDEL™ BB Fiber-coupled LED

*Meticulously engineered photonic tools built to advance the goals of our customers, whether they are forging new paths in scientific discovery or implementing an ongoing project.*



The NewDEL™ BB product group is designed for spectroscopy applications. It encompasses two white light sources with different color temperatures and CRIs, as well as a continuum source. Sources deliver higher efficiency output than omnidirectional mercury arc lamp sources. As with all other members of the product family, each NewDEL™ Broadband model incorporates its own driver and microcontroller circuitry and offers three options for configuration and control.

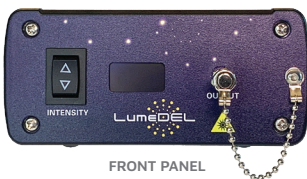

FRONT PANEL



REAR PANEL

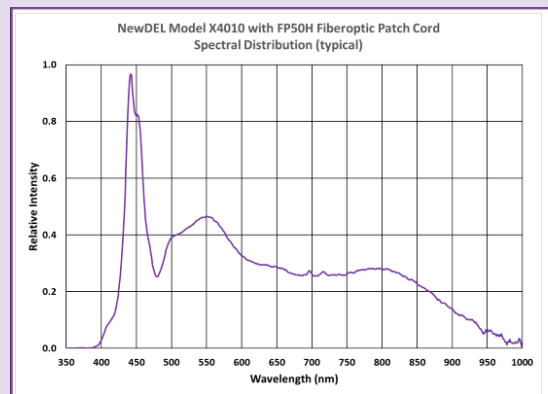

### SPECIFICATIONS

- Broadband Phosphor coated UV-LED (400 nm – 1000 nm)
- Excitation LED Wavelength: 440 nm
- Recommended fiber patch cable: Model **FP50H**, High -OH Silica Optical Fiber, NA 0.50
  - Optical power emitted (typical maximum): **20 mW**
- SMA905 connector (FC option upon request)

### APPLICATIONS

- VIS-NIR spectroscopy
- Product authentication
- Document validation



500 N. Commercial St.  
Suite 502E  
Manchester, NH 03101



P: +1 603.802.2242  
F: +1 603.802.2245

info@lumedel.com  
www.lumedel.com

# NewDEL™ Dimensions

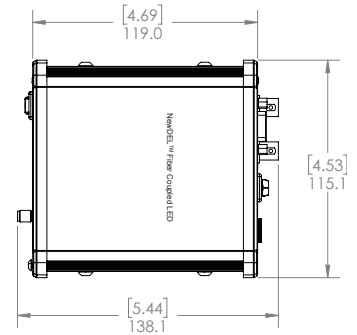
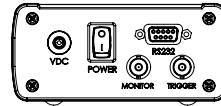
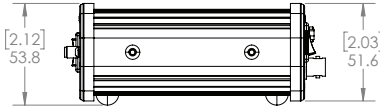
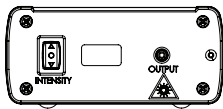

# NewDEL™ Specifications

<b>Optical coupling</b>	SMA 905 type connector for multi-mode optical fibers with core diameters up to 1000 μm (FC connector optional)	2.12 53.8	2.03 51.6
<b>Optical output power (typical)</b>	20 mW		
<b>Wavelength range</b>	400 to 1000 nm		
<b>Operating modes - Pulse Width Modulation</b>	Default 490Hz Custom (user set) 1-500Hz		
<b>Operating modes - Internal Trigger</b>	Set Pulse Delay 10ms – 32s Set Pulse Duration 10ms – 32s		
<b>Operating modes - External Trigger</b>	LED output controlled by 0-5V TTL		
<b>Serial Interface</b>	RS-232, DB-9 female Converter cable RS-232 to USB-A (FTDI) is included		
<b>Trigger connector</b>	Optically isolated BNC, 50 Ohms for External Trigger mode Cable not included		
<b>Monitor connector</b>	BNC, 50 Ohms for reading PWM or pulse waveform Cable not included		
<b>Manual operation</b>	Front panel intensity switch for Pulse Width Modulation mode Step size set by software; 1, 2, 4, 5, or 10 percent		
<b>Remote Operation - Software</b>	Windows based GUI, available by download		
<b>Remote Operation - Programmability</b>	Serial commands are provided to control a unit and query its status using a terminal program or other suitable programming systems		
<b>Front Panel Display</b>	Passive Matrix OLED, can be deactivated through software % PWM Intensity or trigger operating mode with frequency		
<b>Thermal management</b>	Passive cooling via conduction Internal temperature sensor/monitor readable by software		
<b>Power supply</b>	Universal AC/DC Wall adapter, 90 to 264VAC at 47 to 63Hz input 12V 12W output, 1.5 m cord length, DOE VI Efficiency, Class B EMI, Safety Approvals: cUL/UL, RCM, CB, CE (international socket blade options)		
<b>Dimensions/Weight</b>	4.7 x 4.5 x 2.0 in (119.1 x 115.1 x 51.6 mm) / 1.1 lbs (0.5 kg)		

## Peripherals & Accessories

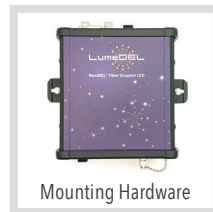

All specifications are subject to change without notice. | All LumeDEL™ Terms and Conditions apply see: <https://lumedel.com/terms-of-sale/>

Copyright © 2023 LumeDEL LLC. All rights reserved.